

Super Profile

Double Partition

**GALCO**

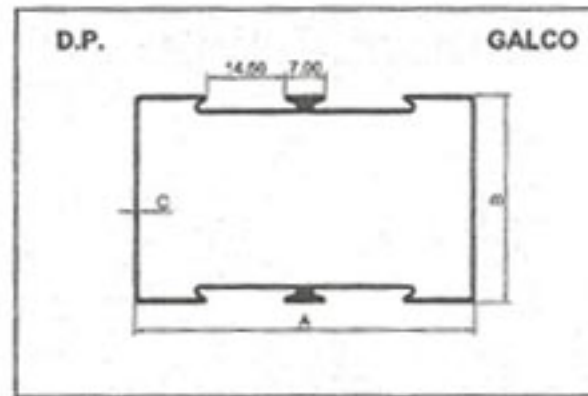

Super Profile

Double Partition

**GALCO**

| Product | A      | B     | C    | Remark | Weight / Mtr |
|---------|--------|-------|------|--------|--------------|
| 780     | 48.00  | 24.00 | 0.00 | 0      | 0.350        |
| 1305    | 62.00  | 36.00 | 0.00 | 0      | 0.500        |
| 1308    | 63.00  | 38.00 | 0.00 | 0      | 0.550        |
| 13002   | 75.20  | 25.40 | 0.00 | 0      | 0.900        |
| 1309    | 82.50  | 38.10 | 0.00 | 0      | 1.400        |
| 800     | 101.60 | 44.45 | 0.00 | 0      | 0.950        |

**GALCO**

Partition Section

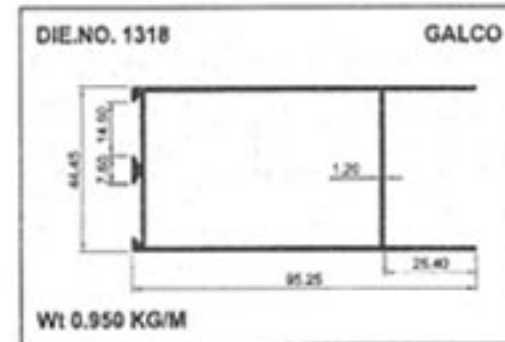
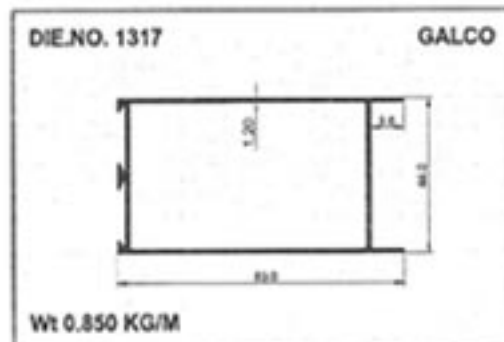
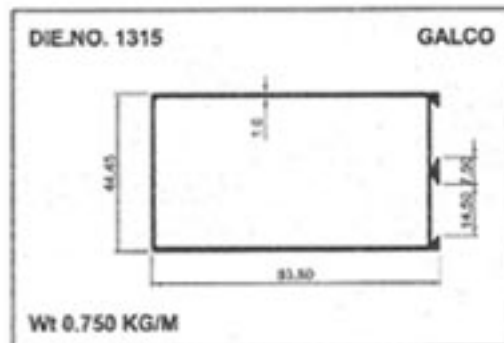
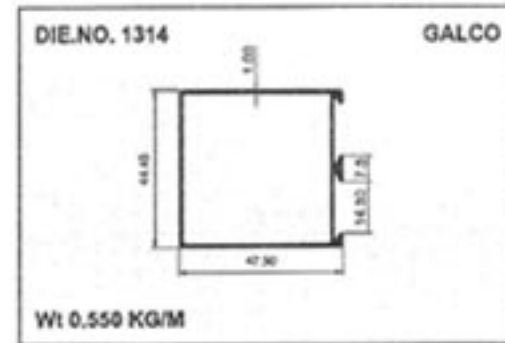
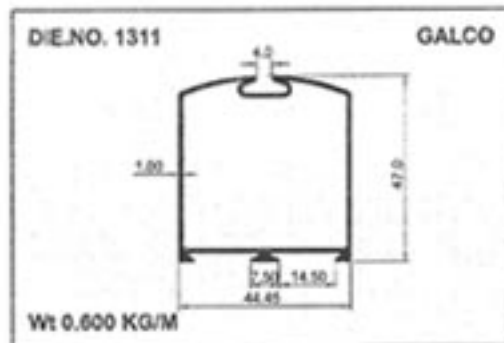
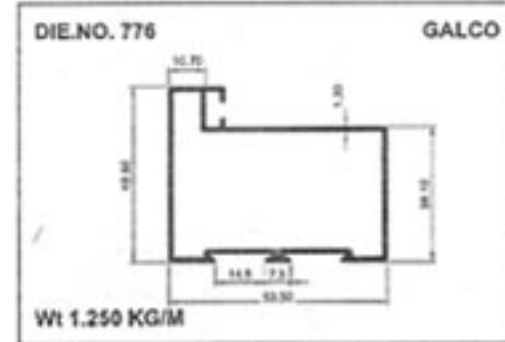
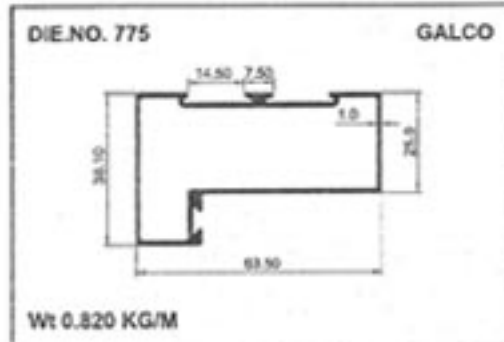

# GALCO

## Partition Section

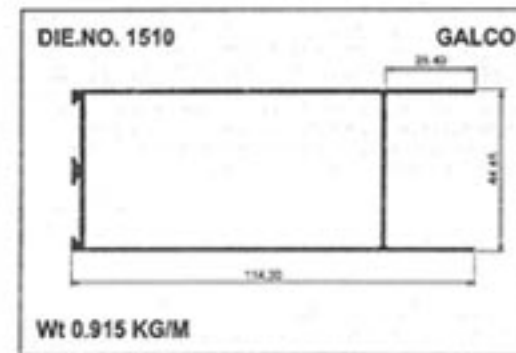
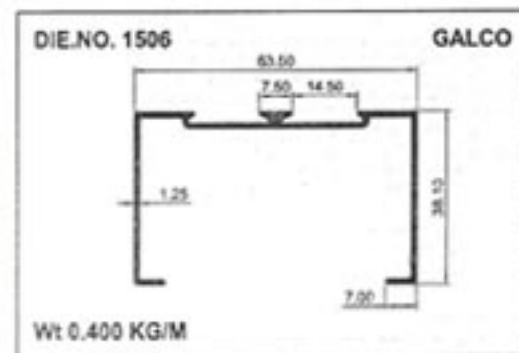
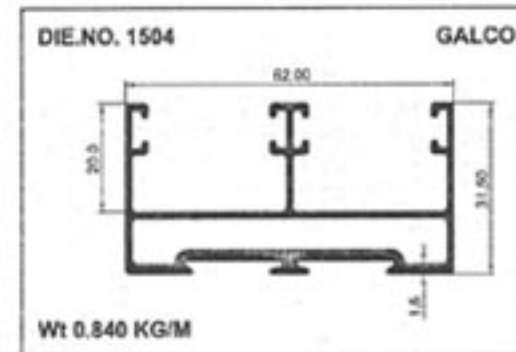
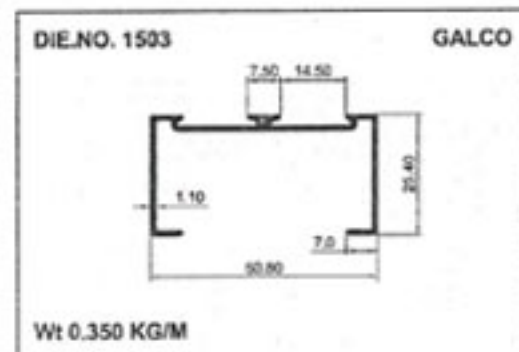
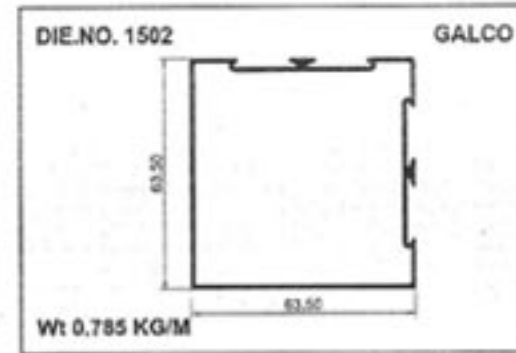
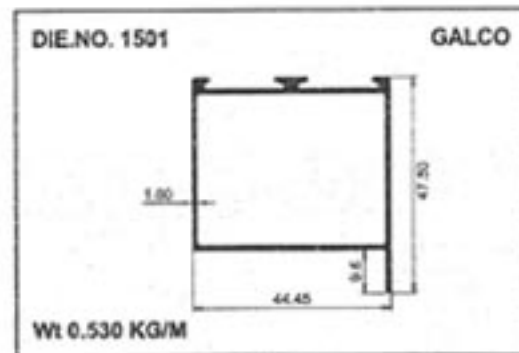
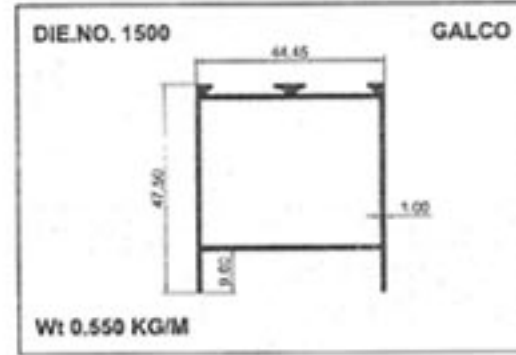
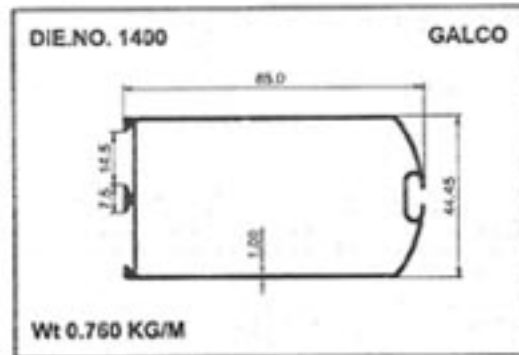

**GALCO**

Partition Section

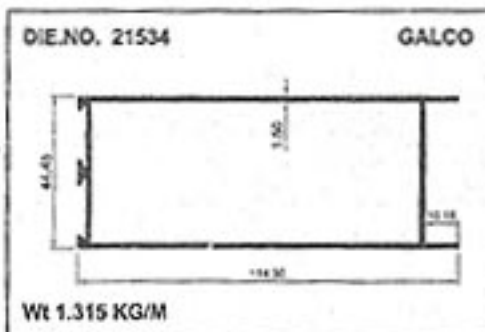
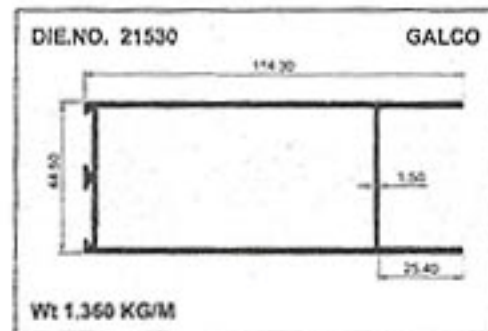
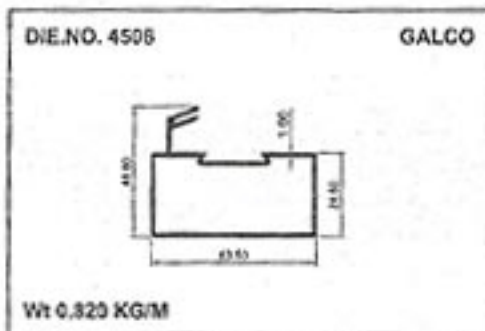
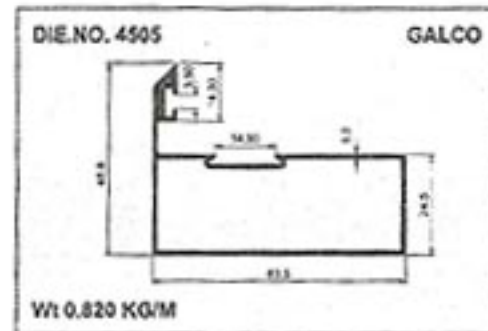
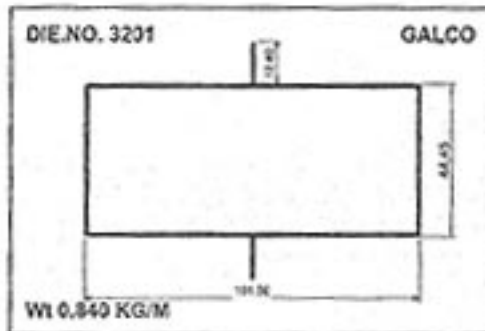
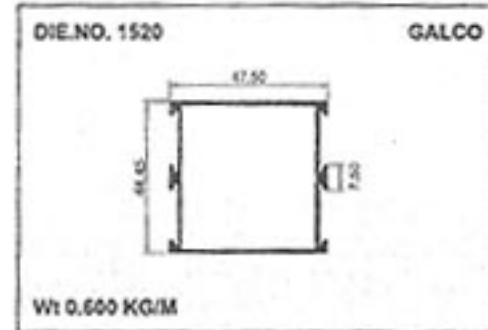
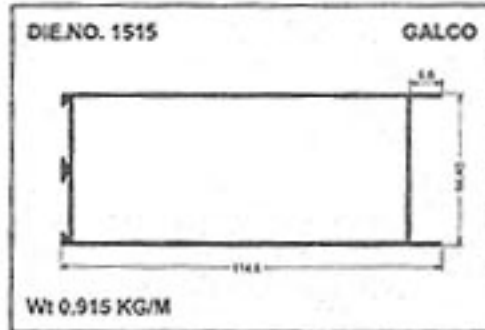

**GALCO**

Corner/Angular Post Partition

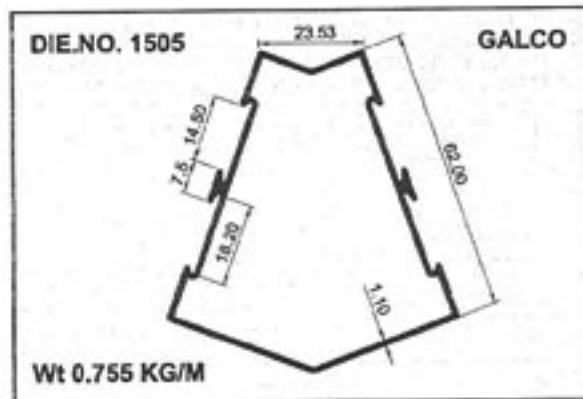

Super Profile

Single Partition

**GALCO**

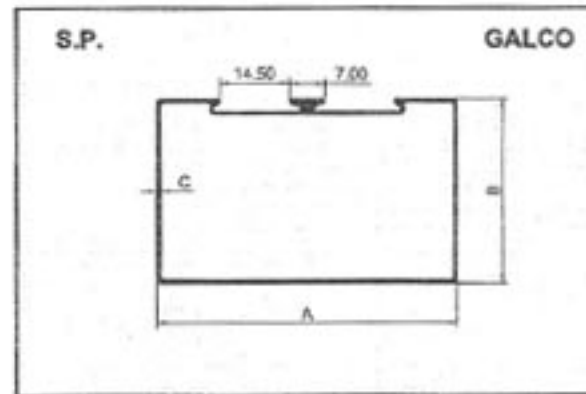

Super Profile

Single Partition

**GALCO**

| Product | A      | B     | C    | Remark | Weight / Mtr |
|---------|--------|-------|------|--------|--------------|
| 760     | 48.00  | 24.00 | 0.00 | 0      | 0.280        |
| 770     | 62.00  | 36.00 | 0.00 | 0      | 0.500        |
| 773     | 63.00  | 38.00 | 0.00 | 0      | 0.430        |
| 13001   | 75.20  | 25.40 | 0.00 | 0      | 0.850        |
| 774     | 82.50  | 38.10 | 0.00 | 0      | 1.370        |
| 790     | 101.60 | 44.45 | 0.00 | 0      | 0.880        |